

Article number: 0105042

Description: Retaining ring AV 25

Note: Fitted with ZGA pliers

Measures

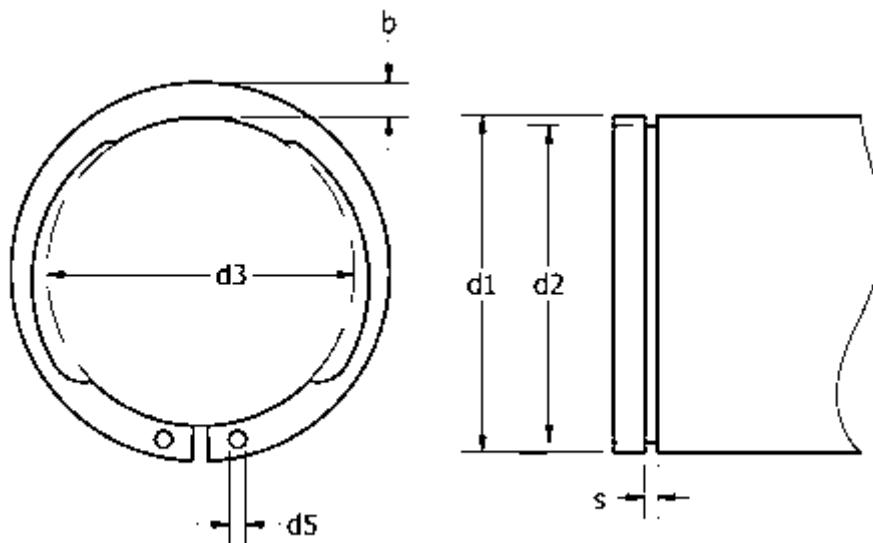

AN mm ²	= 19.1	FRg kN	= 3.2	t	= 0.55
b	= 3.4	FR kN	= 14.1	tol	= -0.06
d1	= 25	g	= 1.5	tol	= -0.21
d2	= 23.9	K kN-mm	= 28.8	tol	= +0,21-0,42
d3	= 23.20	m min	= 1.30	tol	= 0.1
d5 min	= 1.5	n abl x 1000	= 25	Tong	= ZGA-1
Description	= AV 25	s	= 1.20	Weight kg/1000	= 2.10
FN kN	= 3.18	Side power N at I2	= 1.6		